

# MARSTEK VENUS-E

MST-BIE5-2500

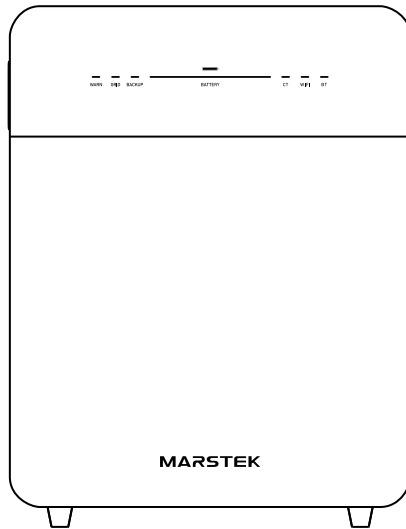

EN

DE

NL

IT

FR

ES

PL

---

# Content

---

|   |           |
|---|-----------|
| <b>1. Product Overview</b>                    | <b>2</b>  |
| 1.1 Introduction                              | 2         |
| 1.2 Model                                     | 2         |
| 1.3 Product Dimensions                        | 2         |
| 1.4 Interface Introduction                    | 3         |
| 1.5 LED Indicators                            | 3         |
| 1.6 Working Modes                             | 4         |
| 1.7 Advanced Function                         | 4         |
| 1.8 System Layout                             | 5         |
| <b>2. Installation Instructions</b>           | <b>6</b>  |
| 2.1 Pre-installation Checklist                | 6         |
| 2.2 Selecting the Installation Site           | 6         |
| 2.3 Installing Accessories and Required Tools | 7         |
| 2.4 Installation Steps                        | 7         |
| <b>3. MARSTEK APP for Smart Control</b>       | <b>10</b> |
| 3.1 QR Code Installation                      | 10        |
| 3.2 Registering and Connecting                | 10        |
| 3.3 Display Information                       | 18        |
| 3.4 Mode Setting                              | 20        |
| <b>4. Maintenance</b>                         | <b>25</b> |
| 4.1 Routine Maintenance                       | 25        |
| 4.2 Trouble Shooting                          | 26        |
| <b>5. Technical Specifications</b>            | <b>30</b> |
| <b>6. Safety Information</b>                  | <b>32</b> |
| <b>7. Appendix</b>                            | <b>34</b> |

# 1.

## Product Overview

### 1.1 Introduction

MARSTEK VENUS-E is an AC-coupled energy storage system, offering three working modes: AI Optimization, Self-Consumption, and Manual. It can be charged by the grid and supply reliable power to both the grid and household loads.

### 1.2 Model

MARSTEK VENUS-E (5 kWh). The table below lists the models covered by this document.

| Product Name    | Product Model |
|-----------------|---------------|
| MARSTEK VENUS-E | MST-BIE5-2500 |

MST-BIEXX-XX

1            2    3            4

|   |                         |   |
|---|-------------------------|---|
| 1 | <b>Company name</b>     | MST: Marstek Energy Co., Limited.           |
| 2 | <b>Series name</b>      | BIE: MARSTEK VENUS                          |
| 3 | <b>Battery capacity</b> | XX: 2.5 means 2.5kWh, 5 means 5kWh          |
| 4 | <b>Power rating</b>     | XX: 2500 means 2500W (Maximum output power) |

### 1.3 Product Dimensions

| Product Name    | Dimensions (mm) |
|-----------------|-----------------|
| MARSTEK VENUS-E | 480*153*624     |

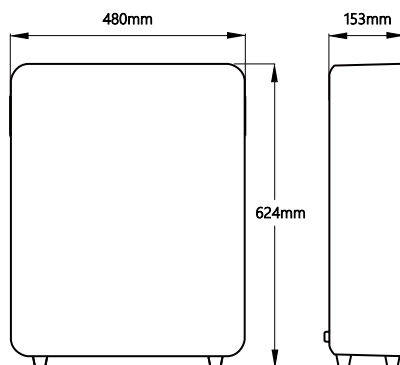

MARSTEK VENUS-E

## 1.4 Interface Introduction

The Product interface layout and definitions are shown below.

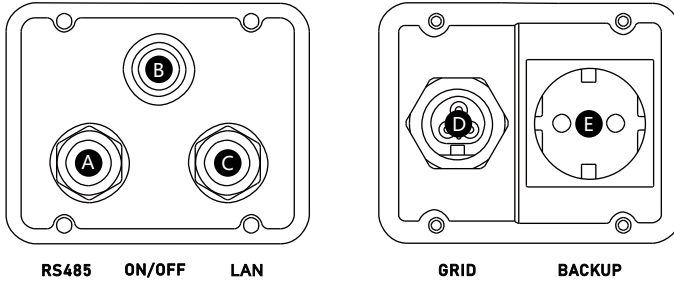

- A** RS485: 485 protocol communication socket.
- B** On/Off Button: Press to turn on/ turn off.
- C** LAN: Wired network connection port.
- D** Grid: Connecting the system to the household grid.
- E** BACKUP: AC socket (EU standard) for powering loads during electricity outages.

## 1.5 LED Indicators

The indicator is located on the front of the product and are used to display the operating status of MARSTEK VENUS-E.

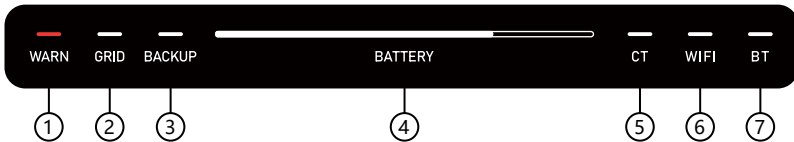

- ①** Error.
- ②** Grid socket on.
- ③** BACKUP socket on.
- ④** Capacity Indicator: Flashing from left to right in charging, right to left in discharging.
- ⑤** CT (Current Transformer) connected.
- ⑥** WiFi connected.
- ⑦** BT (Bluetooth) connected.

| Indicator | Status                            | Description                      |
|-----------|-----------------------------------|----------------------------------|
| Battery   | Off                               | Power off                        |
|           | Steady on                         | Power on                         |
|           | Light bar goes from left to right | Charging in progress             |
|           | Light bar goes from right to left | Discharging in progress          |
| Warn      | Off                               | The device is operating normally |
|           | Red light on                      | Device fault                     |
| Others    | Off                               | Function: Off                    |
|           | Steady on                         | Function: On                     |

## 1.6 Working Modes

- **Self-Consumption:** Requires a current transformer (CT). When the CT detects an active load, the device immediately supplies power. When the CT detects that the solar PV system is feeding electricity back to the grid, the device starts charging to store energy. By working together, the device and CT create an independent home energy management system that maximizes energy efficiency.
- **AI Optimization:** Employs AI algorithms to develop cost-effective charging strategies based on the user's electricity consumption, solar generation, and real-time electricity pricing.
- **Manual:** Executes user-defined charge and discharge strategies.

These three modes can be configured through the app. Please refer to Chapter 3.4 for detailed operation steps.

## 1.7 Advanced Function

### Special Function – Forced Charging

System automatically initiates emergency charging action when battery SOC  $\leq 11\%$  to maintain minimum operational charge level.

### Compensation Function

This function applies to the “Self-Consumption + CT + Load” configuration. When the CT detects active load:

- **Single-Phase Compensation:**
  - MARSTEK VENUS-E supplies power only to the single-phase load connected to the live wire.
- **Three-Phase Total Compensation:**
  - VENUS distributes power across phases A, B, and C based on load demands to keep the net power fed into the grid close to zero, achieving true zero-export.

For multi-device installations at home, three-phase compensation mode is strongly advised for optimal system performance.

## 1.8 System Layout

### Plug-in Solution

The MARSTEK VENUS-E is compatible with all photovoltaic systems, enabling functions such as self-consumption and AI-based optimization. Below are household application scenarios integrated with solar systems.

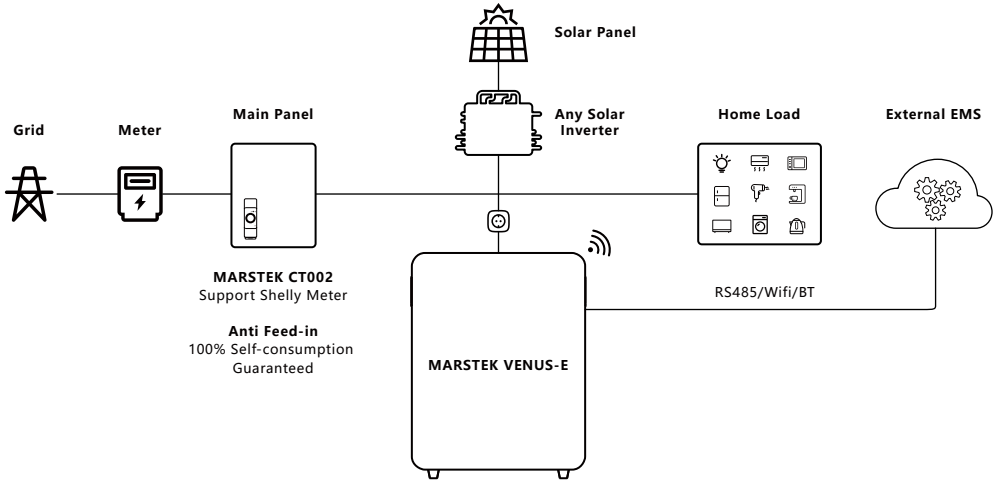

### Whole-house BACKUP Solution

The MARSTEK VENUS-E can also work in coordination with the MARSTEK SmartBox to provide whole-home BACKUP power.

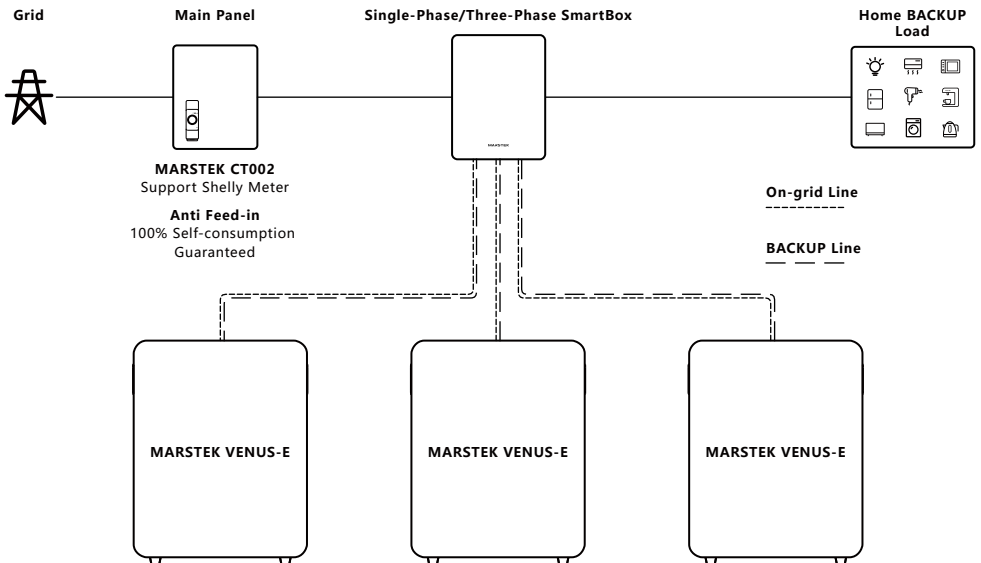

# 2.

## Installation Instructions

### 2.1 Pre-installation Checklist

- Before unpacking the device, inspect the packaging for any visible damage—such as holes, cracks, or other signs that may indicate internal issues—and verify the device's model number. If the packaging is damaged, or if the model number does not match, do not proceed with unpacking. Instead, contact the dealer immediately.
- After unpacking, examine the device for any visible external damage, such as dents, scratches, or other surface defects. Also, verify that all items listed on the packing list are included. If there is any damage or missing items, please contact the dealer or email [info@MARSTEKenergy.com](mailto:info@MARSTEKenergy.com) for assistance.

### 2.2 Selecting the Installation Site

#### Floor Installation & Angle Requirements

- The energy storage device must be installed in an upright position and must not be tilted forward, backward, sideways, or placed horizontally or upside down.

#### Site Notes

- Preferred installation surfaces include solid brick-concrete structures, concrete walls, or floors.
- Alternative surfaces: If other materials (e.g., drywall, wood) are used, they must meet the following conditions:



— Be flame-retardant.



— Meet the load-bearing requirements of the equipment.

#### Clearance & Safety Requirements

- Maintain sufficient clearance around the MARSTEK VENUS-E to ensure proper heat dissipation and safety isolation.
- A minimum clearance of 150 mm must be maintained at the top and rear of the MARSTEK VENUS-E to prevent obstructions and to ensure that no other devices are placed nearby. This is necessary to meet heat dissipation and safety isolation requirements.

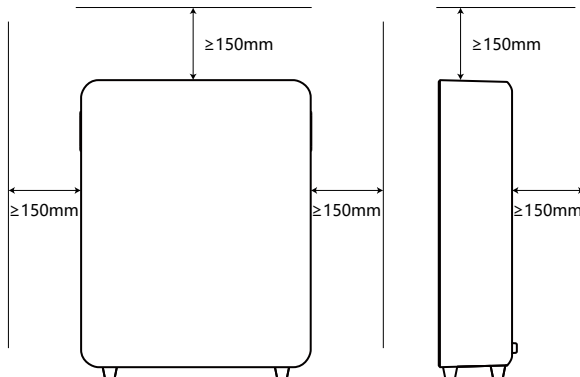

- Prohibited nearby items:
  - Other equipment (except VENUS-compatible devices and approved awnings).
  - Flammable or explosive materials.

## 2.3 Installing Accessories and Required Tools

### Required Accessories

- Before installation, ensure you have the following accessories ready (as listed in the packing list):

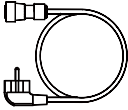

AC Cable×1



Unit-side mounting bracket×1



Wall-side mounting bracket×1

Note: Verify all items with the packing list. If any accessory is missing or damaged, contact your supplier immediately.

### Installing Tools

- Tools below are highly recommended:

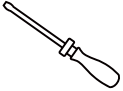

Screwdrivers

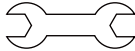

Wrench



Diagonal pliers

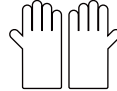

Insulating gloves



Measuring tape

## 2.4 Installation Steps

### Step 1 (Optional step)

- Needed: the MARSTEK VENUS-E device, the unit-side mounting bracket, screws, a screwdriver.
- Actions: Align the screw holes on the unit-side mounting bracket with the corresponding mounting points on both sides of the device. Secure the bracket using the provided screws and a screwdriver.

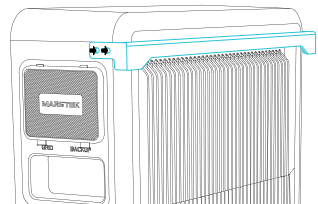
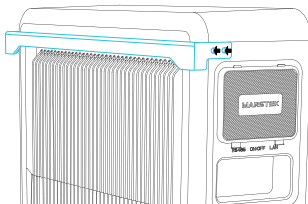

## Step 2 (Optional step)

- Needed: the MARSTEK VENUS-E device, Wall-side mounting bracket, screws, a screwdriver.
- Actions: Secure the wall-side mounting bracket to the wall using screws, then engage the two mounting brackets by interlocking them. The unit will now be firmly wall-mounted.

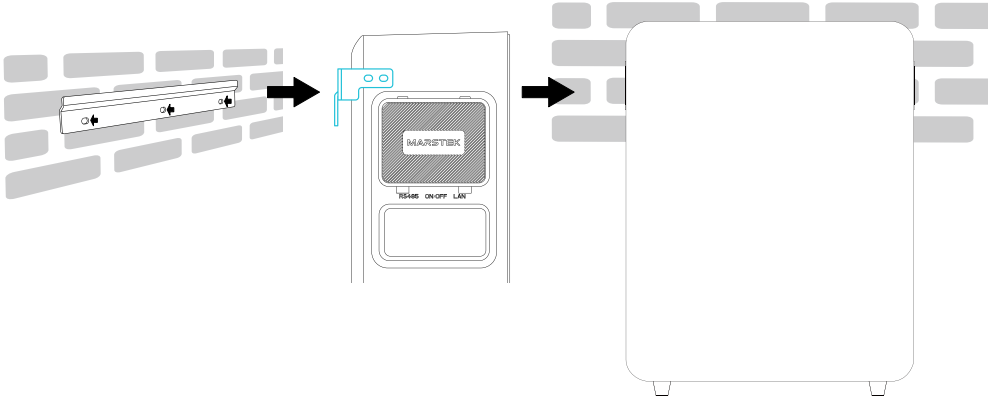

## Step 3

- Needed: the MARSTEK VENUS-E device.
- Actions: Open the cover before wiring.

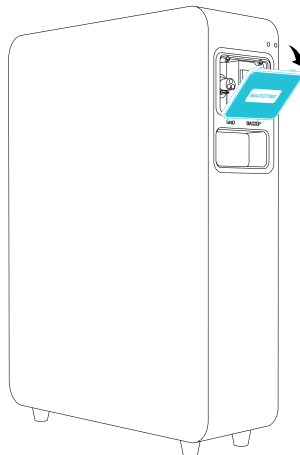

## Step 4

- Needed: the MARSTEK VENUS-E device, AC cable, home-load.
- Actions: For the Grid socket, connect the cylinder-shaped end of the provided AC cable to the VENUS device, and the plug end to the household power socket (city grid). For the BACKUP socket, plug the home load wiring into the BACKUP socket.

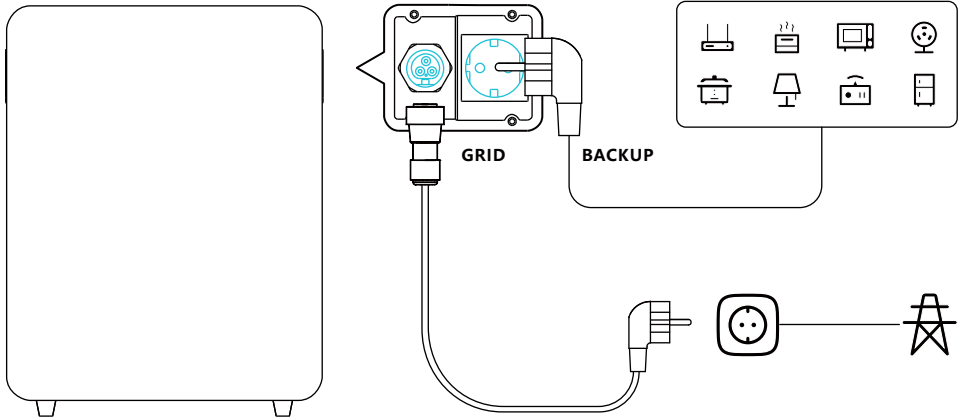

**Warning: DO NOT connect both the Grid and BACKUP sockets of the MARSTEK VENUS-E device to the city power network. Doing so will cause a circuit break or possible device damage.**

## WARNING!

### Compliance Requirements

To ensure operational safety and optimize device longevity, strict adherence to the following PV charging interface and BACKUP socket connection guidelines is mandatory.

Improper wiring may result in:

- Short-circuit incidents due to voltage/current anomalies.
- System failures from current backflow or configuration incompatibility.
- Critical safety hazards including fire risks.

# 3.

## MARSTEK APP for Smart Control

The following instructions are based on Marstek APP v1.6.44 version.

### 3.1 QR Code Installation

Scan the QR code to download the APP.



APP Download

### 3.2 Registering and Connecting

#### First Step: Switch Server

1. Select user's current location from the list.
2. Click **OK** to proceed, and user will be redirected to the **Login Page**.

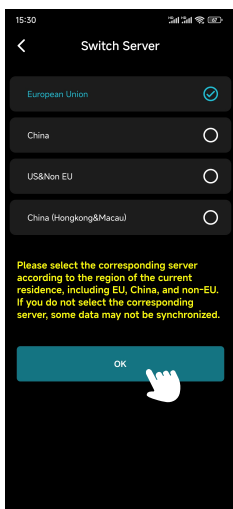

#### Second Step: Login/Register/Forget Password

##### ● Login Page

1. If user have not registered before, click **Register** to go to the **Register Page**.
2. If user forgot user's password, click **Forgot Password** to go to the **Forgot Password Page**.
3. Enter user's email and password under the "User" section.
4. Click **Login**.
5. If user's email and password are correct, user will be redirected to the **Device Management Page**.

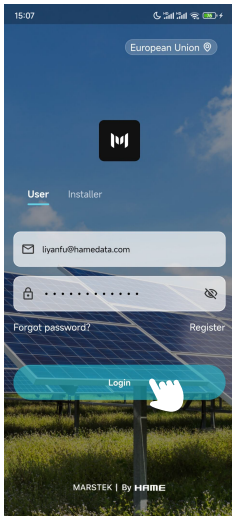

## ● Register Page

1. Enter user's email in the first line.
2. Click **Verification code** and check user's email (including Spam) for the code.
3. Enter the verification code in the second line.
4. Set user's password in the third line and confirm it in the fourth line.  
**Note:** The password must be between **8 and 30 characters**.
5. Read and agree to the **User Privacy Agreement** by checking the box.
6. Click **Register**.
7. Upon successful registration, user will be redirected to the **Login Page**.

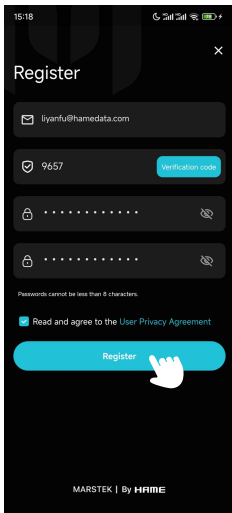

## ● **Forgot Password Page**

1. Enter user's email in the first line.
2. Click **Verification code** and check user's email (including Spam) for the code.
3. Enter the verification code in the second line.
4. Set a new password in the third line and confirm it in the fourth line.
5. Click **Reset Password**.
6. Upon resetting successfully, user will be redirected to the **Login Page**.

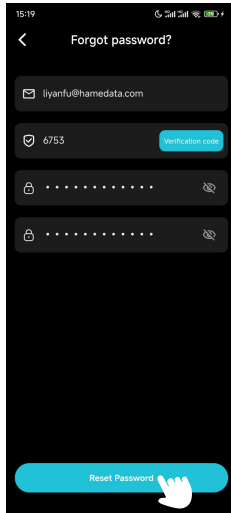

## **Third Step: Add Device**

1. Click the "+" in the top right corner to go to the **Add Device Page**.

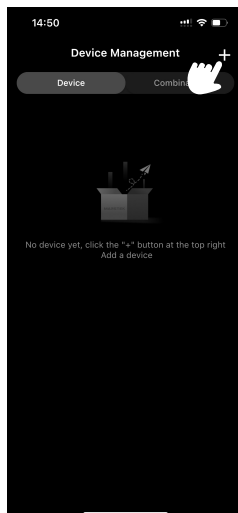

2. Click **Add via Bluetooth** ( Notice: MARSTEK VENUS-E does not currently support adding via QR code).

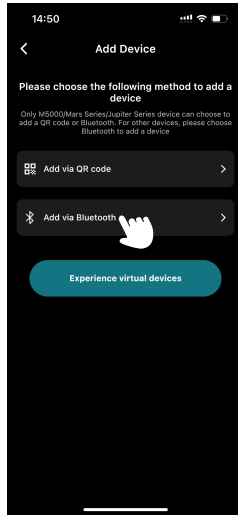

3. Select user's device from the list by identifying its Bluetooth ID(There is a label on the side of the device displaying the Bluetooth ID).

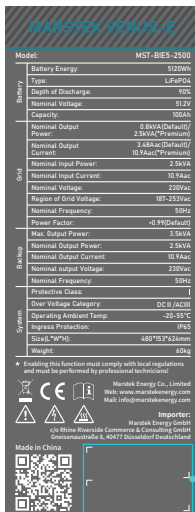

SN code and Bluetooth ID

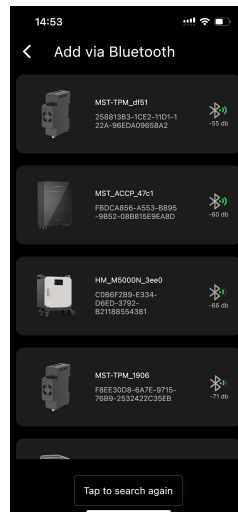

4. Enter a custom name for the product and click **Next**.

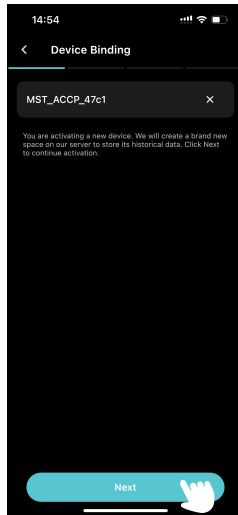

5. Configure Wi-Fi for the device:
- Confirm the Wifi network in the first line.
  - Enter the Wi-Fi password in the second line.
  - Click **Next**.

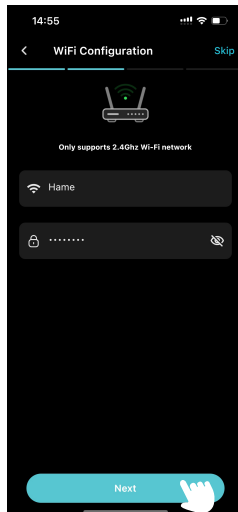

6. Select CT.

a.If the user needs CT, click to add CT device. Otherwise, click **Skip**.

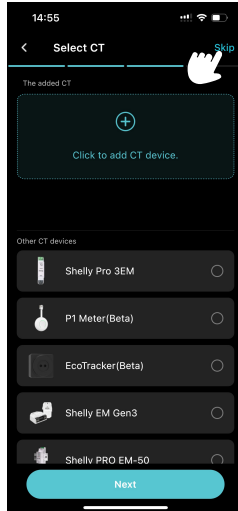

b.Select the CT from the list.



c. The page will turn to **CT Naming Page**, users can customize the name of the CT, then click **Confirm**.

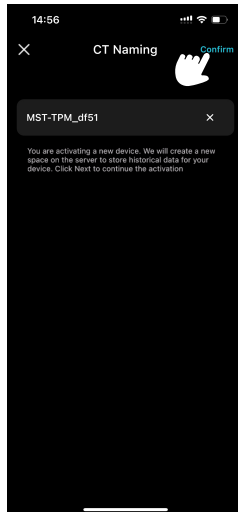

d. Confirm the added CT, and click **Next**.

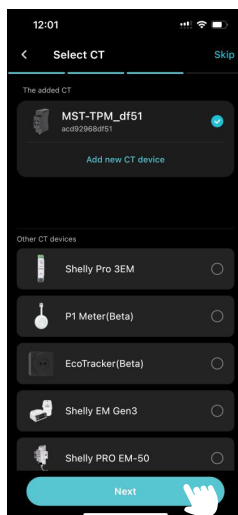

7. Choose a **Charge/Discharge Strategy** and click **Configure**.

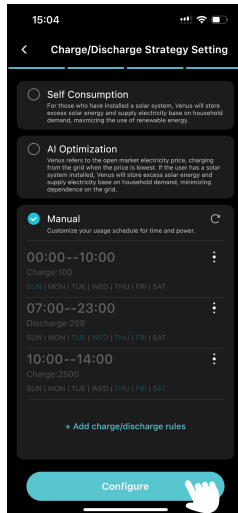

8. Upgrade OTA.

Follow the on-screen instructions to upgrade the OTA to the latest version and click **Done**. (If it is already up to date, simply click **Done**.)

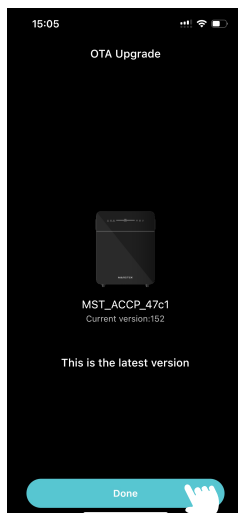

### 3.3 Display Information

**VENUS-E**  
Users can switch devices on the Device Management Page.

**Settings**  
Click here to enter the Settings Page.

**Power**  
Display current charging/discharging power.

**Bluetooth indicator**  
Green: The device is currently connected via Bluetooth.  
Gray: The device is not connected via Bluetooth.

**Charge**  
Charge: The battery is charging.

**Discharge**  
Discharge/Sell electricity: The battery is discharging.

**Wi-Fi indicator**  
Green: The device is connected to a Wi-Fi network.  
Gray: The device is not connected to any Wi-Fi network.

**AC Bypass**  
StandBy/AC bypass: The battery is neither charging nor discharging.

**Battery**  
Show the current energy level and status of charge (SOC) of the battery.

**Earning**  
Display the total amount of money saved.

**Profit Statistics**  
Click here to enter the Profit Statistics Page.

**Cumulative Discharge**  
Click to view historical charge and discharge power.

**Statistics**  
Click here to enter the Statistics Page.

**CT**  
When the VENUS device is successfully paired with the CT (Current Transformer), the indicator light turns on.

**Manual**  
Display selected mode. Click to change mode based on requirements.

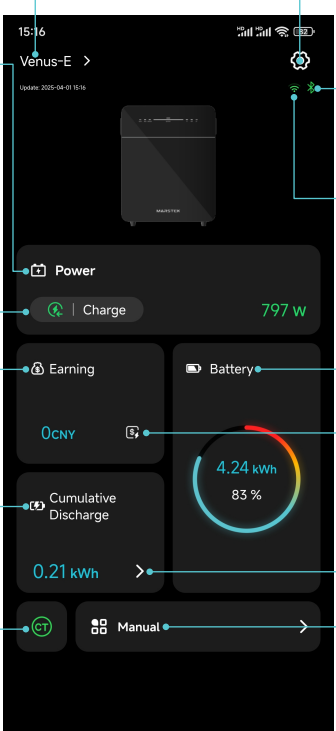

The screenshot shows the main page of the VENUS-E mobile application. At the top, the status bar displays the time 15:16, signal strength, Wi-Fi, and battery icons. Below the status bar, the text 'VENUS-E' is followed by a right-pointing arrow. Underneath, it says 'Update: 2025-04-01 15:16'. A central image shows the VENUS-E device. Below this, there are several widgets: a 'Power' widget with a 'Charge' indicator and '797 W' power; an 'Earning' widget showing '0 CNY'; a 'Battery' widget with a circular progress indicator showing '4.24 kWh' and '83%' SOC; a 'Cumulative Discharge' widget showing '0.21 kWh'; and a 'Manual' widget with a right-pointing arrow. On the right side of the screen, there are status indicators for Bluetooth and Wi-Fi. The bottom of the screen has a navigation bar with icons for Home, Settings, and Manual.

**Main Page**

User can check the historical charging/discharging power statistics (by day, month, or year).

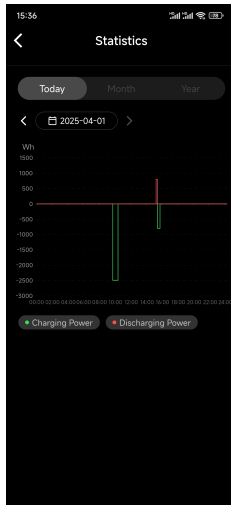

Statistics Page

When the Back Up Enable button is turned on, the MARSTEK VENUS-E BACKUP socket can supply power to the connected load. If the button is off, the BACKUP socket cannot supply power to the connected load.

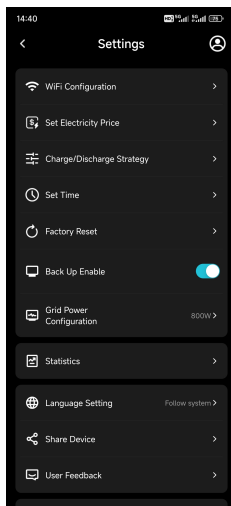

Settings Page

1. Today/Month/Year: switch to the profit data of the current day/month/year.
2. Date: modify the date users want to view here.

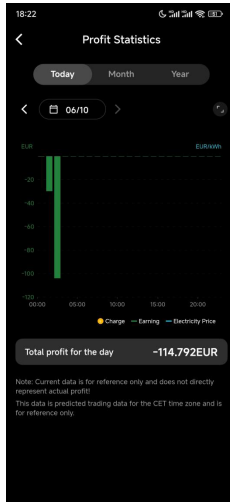

Profit Statistics Page

## 3.4 Mode Setting

### Self Consumption

1. Click **Settings** in the top right corner.

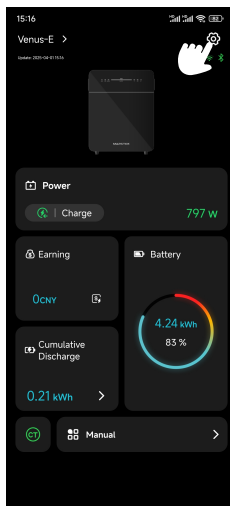

2. Click **Charge/Discharge Strategy** and Navigate to **Charge/Discharge Strategy Setting**.

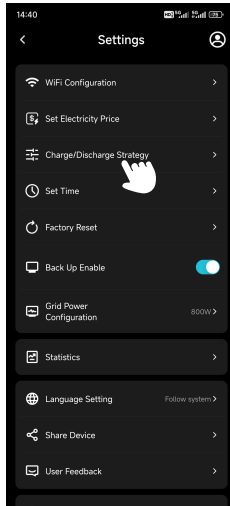

3. Select **Self Consumption** and click **Configure**.

4. Return to the **Main Page** to confirm the current power.

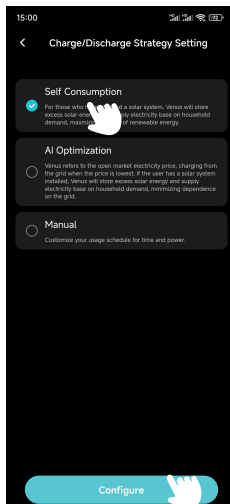

## AI Optimization

1. Click **Settings** in the top right corner.
2. Click **Charge/Discharge Strategy** and navigate to **Charge/Discharge Strategy Setting Page**.
3. Select **AI Optimization**, choose user's location and click **Configure**.

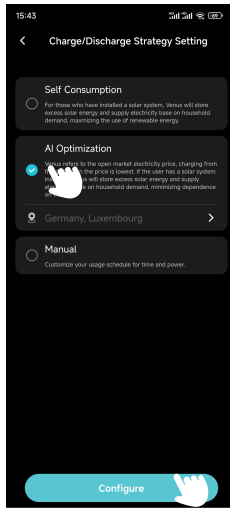

4. Return to the **Main Page** to confirm the current power status.
5. If the user has not manually set a charging price.
  - a. Click **Earning** on the **Main Page** to enter the **Profit Statistics Page** and view the predicted electricity price curve for today.
  - b. The grid will charge MARSTEK VENUS-E when the actual electricity price is lower than the predicted lowest price.

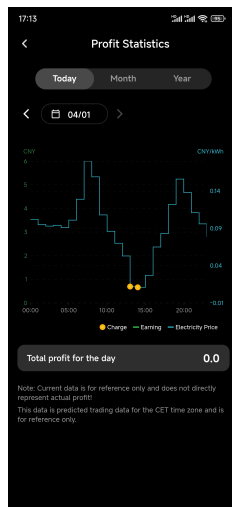
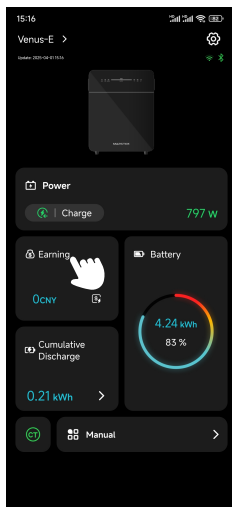

6. If the user has manually set the charging price.
  - a. Click **Settings** in the top right corner.
  - b. Click **Set Electricity Price** and navigate to **Set Electricity Price Page**.

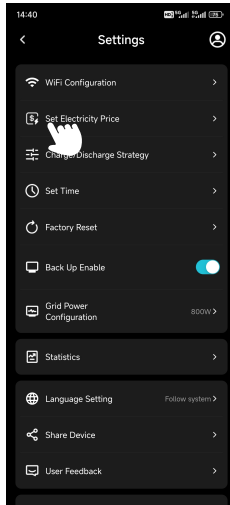

- c. Set **Currency, Charging Price** and click **OK**.
    - d. The grid will charge MARSTEK VENUS-E when the actual electricity price is lower than the set price.

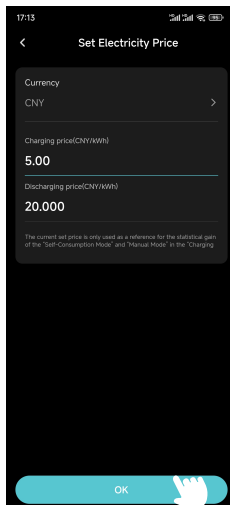

## Manual

1. Click **Settings** in the top right corner.
2. Click **Charge/Discharge Strategy** and navigate to **Charge/Discharge Strategy Setting**.
3. Select **Manual**, Click **+Add charge/discharge rules** and navigate to the **Edit Page**.
4. Set the **Start Time**, **End Time**, **Charge or Discharge Power**, **Days of the Week** and click **OK**.
5. Click **Configure**.
6. Return to the **Main Page** to verify the current power status.

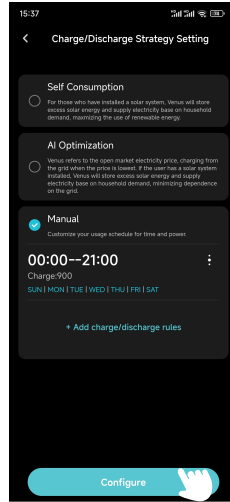
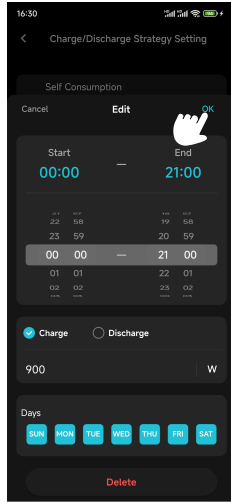







# 4.

## Maintenance

### 4.1 Routine Maintenance

- Maintenance work should only be performed by authorized personnel.
- When conducting maintenance, make sure to wear personal protective equipment.
- During normal operation of the MARSTEK VENUS-E, make sure the environmental conditions meet the requirements of the "Technical Specifications". Additionally, the equipment is not exposed to severe weather.
- If the device has problems, do not use it. When problems are solved, resume normal usage.
- Check the MARSTEK VENUS-E at least once a year to ensure that each component is in good condition. The heat dissipation components are not blocked in any way.
- To clean the device, use a vacuum cleaner or a special brush.

|  |                                 |  |
|--|---------------------------------|--|
|    | Do Not Dismantle                | The MARSTEK VENUS-E should only be serviced by authorized personnel. Users are strictly prohibited from repairing any internal parts to ensure safety and maintain insulation performance. |
|    | AC Output Harness               | The AC output harness (also known as the AC tapping cable) must not be replaced. If the wires become damaged, the entire device must be scrapped.  |
|    | Disconnection from Power Source | Unless specified conditions, otherwise, always disconnect the device from the grid by unplugging it from the socket before performing any maintenance or repairs.                          |
|   | Cleaning Instructions           | Do not use cleaning rags made from filamentous or corrosive materials, as these can generate static electricity or cause corrosion.  |
|  | Repairs                         | Do not attempt to repair the product yourself. Always use qualified parts when servicing the device.   |
|  | Circuit Breaker Requirements    | Ensure that each branch line is equipped with a circuit breaker; however, a central protective device is not necessary.  |

## 4.2 Trouble Shooting

In the event of device malfunction, please follow these steps:

- Verify all electrical connections and battery status.
- Restart the system following the proper power cycling procedure.
- Consult the User Manual or FAQ section for known issues and resolutions.

Should the issue persist, please contact our Customer Support Department with the following information:

- Complete device specifications.
- Detailed description of the fault condition.
- Any observed error codes or indicators.

If needed, the support team will provide a guidance on sending the device for repair and a solution within 7 business days. Warranty coverage includes free repair or replacement; otherwise, a repair quote will be provided.

| Codes   | Alarm range   | Alarm status                          | Suggested treatments   |
|---------|---------------|---------------------------------------|--|
| 400     | Inverter Side | Overheat Protection                   | <ol style="list-style-type: none"> <li>1. Check the ventilation in the inverter installation area and whether the ambient temperature exceeds the maximum allowable range.</li> <li>2. If ventilation is insufficient or the temperature exceeds the range, please improve its ventilation and heat dissipation conditions.</li> <li>3. If the issue remains unsolved, please contact the technical team.</li> </ol> |
| 401     | Inverter Side | Self-test failed                      | <ol style="list-style-type: none"> <li>1. Please try to restart.</li> <li>2. If the issue remains unsolved, please contact the technical team.</li> </ol>  |
| 402     | Inverter Side | Eeprom read and write exception       | <ol style="list-style-type: none"> <li>1. Please try to restart.</li> <li>2. If the issue remains unsolved, please contact the technical team.</li> </ol>  |
| 405     | Inverter Side | Off-grid output over-power protection | <ol style="list-style-type: none"> <li>1. The instantaneous power on the off-grid side is too high, please reduce the off-grid power consumption.</li> <li>2. If the issue persists at low power loads, please contact the technical team.</li> </ol>  |
| 410-430 | Inverter Side | Abnormality within the device         | <ol style="list-style-type: none"> <li>1. Wait half a minute for the inverter to return to normal.</li> <li>2. If the issue remains unsolved, please try to restart or contact the technical team.</li> </ol>  |

|         |           |                                |   |
|---------|-----------|--------------------------------|---|
| 431     | BAT Side  | Unable to communicate with BMS | <ol style="list-style-type: none"> <li>1. It may be caused by low battery voltage. Connect the battery to reactivate within 5 minutes. The issue disappears after the activation.</li> <li>2. If the issue remains unsolved, please try to contact the technical team.</li> </ol> |
| 432     | BAT Side  | Battery overvoltage            | If the issue remains unsolved, please try to contact the technical team.  |
| 433     | BAT Side  | Battery overcurrent            | If the issue remains unsolved, please try to contact the technical team.  |
| 434     | BAT Side  | Battery undervoltage           | <ol style="list-style-type: none"> <li>1. Please ensure the grid-connected socket is properly connected.</li> <li>2. If the issue remains unsolved, please try to contact the technical team.</li> </ol>  |
| 440/441 | Grid Side | Grid overvoltage               | <ol style="list-style-type: none"> <li>1. Grid fluctuations and loose connections may trigger this fault.</li> <li>2. Check whether the grid is properly connected and wait for the grid to return to normal.</li> </ol>  |
| 442     | Grid Side | Grid undervoltage              | <ol style="list-style-type: none"> <li>1. Grid fluctuations and loose lines may trigger this fault.</li> <li>2. Check whether the grid is connected correctly and wait for the grid to return to normal.</li> </ol>   |
| 443     | Grid Side | Grid overfrequency             | <ol style="list-style-type: none"> <li>1. Grid fluctuations and loose lines may trigger this fault.</li> <li>2. Check whether the grid is connected correctly and wait for the grid to return to normal.</li> </ol>   |
| 444     | Grid Side | Grid underfrequency            | <ol style="list-style-type: none"> <li>1. Grid fluctuations and loose lines may trigger this fault.</li> <li>2. Check whether the grid is connected correctly and wait for the grid to return to normal.</li> </ol>   |
| 445     | Grid Side | Grid-connected overcurrent     | <ol style="list-style-type: none"> <li>1. Check if the grid is properly connected. If so, it will return to normal within one minute.</li> <li>2. Restart the inverter.</li> <li>3. If the issue remains unsolved, please try to contact the technical team.</li> </ol>           |

|                 |               |  |  |
|-----------------|---------------|--|--|
| 446             | Grid Side     | Grid fluctuations  | <ol style="list-style-type: none"> <li>1. Grid fluctuations and loose lines may trigger this fault.</li> <li>2. Check whether the grid is connected correctly and wait for the grid to return to normal.</li> </ol>  |
| 447             | Inverter Side | DCI protection/<br>output DC<br>component<br>protection          | <ol style="list-style-type: none"> <li>1. Grid fluctuations and loose lines may trigger this fault.</li> <li>2. Check whether the grid is connected correctly and wait for the grid to return to normal.</li> </ol>  |
| 448             | Inverter Side | DCV protection/grid<br>voltage direct<br>component<br>protection | <ol style="list-style-type: none"> <li>1. Grid fluctuations and loose lines may trigger this fault.</li> <li>2. Check whether the grid is connected correctly and wait for the grid to return to normal.</li> </ol>  |
| 530/558         |               | Over temperature<br>limit  | <ol style="list-style-type: none"> <li>1. Check the ventilation in the inverter installation area and whether the ambient temperature exceeds the maximum allowable range.</li> <li>2. If ventilation is insufficient or the temperature exceeds the range, please improve its ventilation and heat dissipation conditions.</li> <li>3. If the issue remains unsolved, please contact the technical team.</li> </ol> |
| 559             |               | Low temperature<br>limit   | <ol style="list-style-type: none"> <li>1. Check whether the ambient temperature meets the requirements.</li> <li>2. If the ambient temperature is normal but the issue remains unsolved, please try to contact the technical team.</li> </ol>  |
| 560             |               | Low battery  | <ol style="list-style-type: none"> <li>1. The issue may be caused by the battery low power, please connect the grid.</li> <li>2. If the issue remains unsolved, please try to contact the technical team.</li> </ol>   |
| 5C0             |               | Bluetooth status<br>is abnormal                                  | <ol style="list-style-type: none"> <li>1. Check if the correct device and APP are being connected. The issue will be solved after a period of time.</li> <li>2. If the issue remains unsolved, please try to contact the technical team.</li> </ol>  |
| 5C1             |               | OTA update failed  | <ol style="list-style-type: none"> <li>1. The issue will be solved after re-upgrading.</li> <li>2. If the issue remains unsolved, please try to contact the technical team.</li> </ol>   |
| 5C2/5C3<br>/5C4 |               | Abnormal<br>WiFi signal  | <ol style="list-style-type: none"> <li>1. Check if the Wi-Fi connection between the device and home network is stable.</li> <li>2. If the issue remains unsolved, please try to contact the technical team.</li> </ol>   |

|         |  |                           |   |
|---------|--|---------------------------|---|
| 5C8-5CB |  | Network abnormal          | <ol style="list-style-type: none"> <li>1. Check if the home network is normal, the issue may occur occasionally due to network fluctuations and will automatically resolve after a while.</li> <li>2. If the issue remains unsolved, please try to contact the technical team.</li> </ol> |
| 5D2     |  | CT connection abnormality | <ol style="list-style-type: none"> <li>1. Check if the the CT is properly connected to the home network and ensure the home network is stable.</li> <li>2. If the issue remains unsolved, please try to contact the technical team.</li> </ol>  |

# 5.

## Technical Specifications

| Specification Type          | MARSTEK VENUS-E                                    |
|-----------------------------|--|
| <b>Battery Info</b>         |  |
| Rated Voltage               | 51.2V  |
| Battery Energy              | 5120Wh   |
| Life Cycle (Times)          | >6000(25°C)  |
| Battery Type                | LiFePO4  |
| Depth of Discharge          | 90%  |
| Capacity                    | 100Ah  |
| <b>AC Input (On Grid)</b>   |  |
| Rated Power                 | 2.5kW  |
| Grid Connection Type        | L/N/PE   |
| Rated Grid Voltage          | 230V   |
| Grid Voltage Range          | 187V-253V  |
| Rated Grid Frequency        | 50Hz   |
| Rated Grid Current          | 10.9A  |
| Power Factor                | >0.99(Default)/0.8 Leading~0.8 Lagging(Adjustable) |
| THDi                        | <3%  |
| <b>AC Output (On Grid)</b>  |  |
| Rated Power                 | 0.8kW(Default)/2.5kW(*Premium)                     |
| Grid Connection Type        | L/N/PE   |
| Rated Grid Voltage          | 230V   |
| Grid Voltage Range          | 187V-253V  |
| Rated Grid Frequency        | 50Hz   |
| Rated Grid Current          | 3.48A(Default)/10.9A(*Premium)                     |
| Power Factor                | >0.99(Default)/0.8 Leading~0.8 Lagging(Adjustable) |
| THDi                        | <3%  |
| <b>AC Output (Off Grid)</b> |  |
| Rated Off-grid Output Power | 2.5kVA   |
| Max.Output Power            | 3.5kVA,10s   |
| Rated Output Current        | 10.9A  |
| Rated Output Voltage        | 230V   |
| Rated Output Voltage Freq.  | 50Hz   |
| THDu(Linear Load)           | <3%  |

| Efficiency                           |                                       |
|--------------------------------------|---------------------------------------|
| Battery-AC Side Max.Efficiency       | >93.5%                                |
| Protection                           |                                       |
| Protection level                     | I                                     |
| Oversvoltage/Voltage Withstand Level | DC II/AC III                          |
| General Parameter                    |                                       |
| Isolation Type                       | Isolated                              |
| Operating Temperature Range          | -20 ~+ 55°C(Store-30 ~+ 85°C)         |
| Relative humidity                    | 0-95%                                 |
| Ingress Protection                   | IP65                                  |
| Cooling Strategy                     | Natural Convection                    |
| Max.Operating Altitude               | 2000m                                 |
| On-grid Connection Standard          | EN50549-1                             |
| Regulatory                           | IEC62040、IEC62477                     |
| EMC                                  | IEC/EN 61000-6-1/-2/-3/-4             |
| Dimension(L*W*H)                     | 480*153*624mm                         |
| Weight                               | 60kg                                  |
| Addition Date                        |                                       |
| On-grid AC Connection                | Three-wire Household Plug(Euro16A)    |
| Display                              | LED                                   |
| Supported Communication Interface    | WiFi&RS-485(Waterproof Aviation Plug) |

Note 1: Rated voltage/frequency range can be changed according to the requirements of the local power department.

Note 2: Please refer to local electrical regulations to determine the number of the MARSTEK VENUS units that can be connected to each branch circuit.

\*Enabling this function must comply with local regulations and should only be performed by authorized personnel!

# 6.

## Safety Information

### Safety Precaution

- The MARSTEK VENUS-E series has been designed and tested in accordance with international safety standards. However, safety regulations must still be followed during the installation and operation of the MARSTEK VENUS-E series. Installers must carefully read, fully understand, and strictly comply with all instructions, precautions, and warnings in this installation manual.
- It is strictly prohibited to reverse engineer, decompile, disassemble, adapt, implant, or perform any other derivative operations with the device software. Studying the internal implementation logic, obtaining the source code, infringing intellectual property rights in any way, or disclosing the results of software performance tests is also forbidden.
- All operations including transportation, storage, installation, usage and maintenance must comply with applicable laws, regulations, standards and specifications.
- This equipment must be used in an environment that meets the specified design conditions. Any Equipment failure, malfunction, or component damage caused by an improper environment is not covered under the product's quality assurance. The company will not be liable for any compensation related to personal injury, property loss, etc.

### The Company shall not be liable for any of the following circumstances or their consequences:

- Equipment damage caused by natural disasters eg. earthquakes, floods, volcanic eruption, mudslides, lightning strikes, fires, wars, armed conflicts, typhoons, hurricanes, tornadoes, extreme weather, or force majeure events.
- Failure to operate the equipment within the conditions specified in this manual.
- Installation and usage in environments that do not comply with relevant international, national, or regional standards. Installation or operation conducted by authorized personnel.
- Failure to follow the operating instructions and safety warnings provided in the product documentation.
- Unauthorized disassembly, modification of the product including alternations to the software code.
- Damage incurred during transportation by the user or by a third party acting on behalf of the user.
- Damage resulting from storage conditions that do not meet the product documentation requirements.
- Use of materials and tools that violate local laws, regulations, or applicable standards.
- Damage resulting from negligence, gross negligence, intentional misconduct, improper operation, or any other causes not attributable to the Company.

### Personal Safety

- Ensure that power is turned off before installation. Do not install or remove cables while the power is on.
- Non-standard or improper operation on energized equipment may result in fire, electric shock, or explosion, causing property damage, personal injury, or even death.
- Before beginning any operation, remove conductive objects such as watches, bracelets, rings, and necklaces to avoid electric shock.
- Use dedicated insulated tools during operation to prevent electric shock or short circuits.

- Do not directly or indirectly contact with other conductors or indirectly contact power supply equipment through damp or wet objects.
- Do not power on the equipment until it has been correctly installed or confirmed by a professional.
- Only qualified professionals or properly trained personnel are allowed to install, operate, or maintain this equipment.
- If there is any risk of personal injury or equipment damage during operation, cease work immediately and report the incident.
- Do not touch the equipment when energized, as its surface may be hot.

## **Electricity Safety**

- Before installation, ensure that the equipment is intact. Otherwise, electric shocks or fires may occur.
- Non-standard and improper operations may result in fire or electric shocks.
- Prevent foreign matter from entering the equipment during operations.
- For the equipment that needs to be grounded, install the ground cables first when installing the equipment and remove the ground cables last when removing the equipment.
- Disconnect the equipment and its switches before installing or removing any power cables.
- Do not damage the grounding conductors.
- Equipment terminals should only be used for electrical connections.
- Ensure all electrical connections comply with local electrical codes and standards.
- Approval from the local utility company must be obtained before operating in grid-tied mode.
- Use dedicated insulated tools for all high-voltage operations.
- Repairs must be performed with qualified and compliant parts, installed by an authorized contractor or service representative of Marstek Energy Co., Limited. Such components must only be used for their intended and certified purposes.
- Do not expose the equipment to flammable or explosive gas or smoke. Do not perform any operation on the equipment in such environments.
- Do not store any flammable or explosive materials near the equipment.
- Install the equipment in a dry, well-ventilated area, away from any liquids.
- Ensure ventilation openings or heat dissipation systems are not blocked to prevent overheating or fire.

## **Mechanical Safety**

- Do not drill holes into the equipment.
- Wear goggles and protective gloves when drilling holes.
- Be cautious to avoid injury when moving heavy objects.

# 7.

## Appendix

### What's in the box

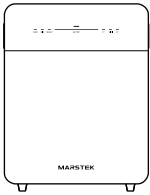

VENUS-E×1

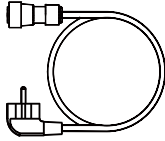

AC Cable×1



Warranty Card×1

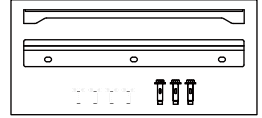

Mountings×1 set